

Outdoor furniture with
a *Mediterranean* flare

Siente la brisa mediterránea, el sol y la serenidad de la naturaleza. OGO es una marca nacida en las islas, que fusiona la calma con el diseño contemporáneo. Cada pieza refleja nuestras raíces, con colores y formas que evocan tranquilidad y estilo atemporal.

Feel the mediterranean breeze, the warmth of the sun, and the serenity of nature. OGO is a brand born from the islands, blending calm with contemporary design. Each piece reflects our roots, with colours and forms that evoke tranquility and a sense of timeless style.

Casi una década de color y diseño

Con casi una década de experiencia, OGO ha estado creando diseños que transforman los espacios en refugios de relajación y disfrute. Nacidos de la belleza natural de las islas, nuestras piezas son un homenaje a la serenidad, fusionando diseño innovador con estilo atemporal. Cada producto que creamos refleja nuestras raíces, con el objetivo de convertir tu entorno en un lugar de confort y tranquilidad. Honramos nuestro pasado, mientras damos forma al futuro de los espacios que inspiran paz y alegría.

Almost a decade of colour and design

With nearly a decade of experience, OGO has been crafting designs that transform spaces into havens of relaxation and enjoyment. Born from the island's natural beauty, our pieces are a tribute to serenity, blending innovative design with timeless style. Each product we create is a reflection of our roots, aimed at making your surroundings a place of comfort and tranquility. We honor our past, while shaping the future of spaces that inspire peace and joy.





**Versatilidad,
funcionalidad y estilo**

OGO se especializa en la creación de muebles innovadores y versátiles que se adaptan a la perfección tanto a espacios interiores como exteriores. Centrada en la calidad artesanal y el diseño sostenible, la marca combina colores vivos, materiales duraderos y confort ergonómico. Ya sea para villas privadas, salones de hotel o espacios de *coworking*, OGO ofrece soluciones a medida para mejorar cualquier entorno, manteniendo siempre la funcionalidad y el estilo.

**Versatility, functionality
and aesthetics**

OGO specializes in creating innovative, versatile furniture that seamlessly adapts to both indoor and outdoor spaces. With a focus on quality craftsmanship and sustainable design, the brand combines vibrant colours, durable materials, and ergonomic comfort. Whether for private villas, hotel lounges, or coworking spaces, OGO offers tailored solutions to enhance any setting, always keeping functionality and style at the forefront.

Our vision

Timeless furniture that
transforms any space into
a garden of relaxation





Photography by Jorge Galván, Canary Islands, Spain



We honor
our
island
roots

Playa de Cofete, Fuerteventura

Index

Explore our *collections*, crafted to suit every space and style: pool, terrace, indoor and beyond.

OGO ofrece una gama de muebles para cada espacio -interior, exterior y junto a la piscina- diseñados para aportar comodidad, estilo y versatilidad.

OGO offers a range of furniture for every space—indoor, outdoor, and poolside—designed to bring comfort, style, and versatility.



Bali
by OGO Furniture

p. 14



Llit Out
by OGO Furniture

p. 18



María
by OGO Furniture

p. 22



Starfish
by Nacho Timón

p. 26



Sit Pool
by OGO Furniture

p. 32



Sit Pool Sunbed
by OGO Furniture

p. 36



Don Out Collection
by Nacho Timón

p. 42



Bloom Out
Don Out by Nacho Timón
Bloom Base by Adán D. Modesto

p. 48



Flower
by Nacho Timón

p. 52



Lola G
by Ana Llácer

p. 60



Perla
by OGO Furniture

p. 64



Mandarina
by Nacho Timón

p. 66



Duna Collection
by OGO Furniture

p. 68



Tote Bag
by OGO Furniture

p. 80



Dot Cushion
by Adán D. Modesto

p. 84



Cactus
by OGO Furniture

p. 88

Splash! ,

Open Air,

Collective ,

Lab

Encuentra el producto que mejor se adapta a tus necesidades

OGO apuesta por piezas que encajan a la perfección en cualquier espacio, tanto en interior como en exteriores. Desde los primeros bocetos hasta el resultado final, cuidamos cada detalle con una idea clara: que sientas que cada producto que adquieras está donde siempre tuvo que estar. En la oficina, en el salón o en la piscina. OGO está contigo en tus mejores momentos.

Find the product that best suits your needs

OGO designs pieces that blend effortlessly into any space, indoors or outdoors. From the first sketch to the finished product, we focus on every detail with one goal in mind: to make each piece feel like it was always meant to be there. Whether it's in the office, at home, in the living room, or by the pool —OGO belongs in your best moments.

Explore our collections and let yourself be carried away by the slow *mediterranean* life.

Splash!

Durabilidad, estilo y una buena dosis de diversión. Los productos de la colección Splash! han sido diseñados precisamente para disfrutar en la piscina. Su tejido tridimensional los convierte en compañeros ideales para pasar el día en el agua.

Todos los productos con esta etiqueta son aptos para uso en el agua, gracias a su específica combinación de forma, relleno y tejido.

Durability, style, and a splash of fun. The products in this collection are designed specifically for enjoying time by the pool. Their three-dimensional fabric makes them the perfect companions for a day in the water.

All products with this label are suitable for use in water, thanks to their specific combination of shape, filling and fabric.

Open Air

Elegancia, comodidad y personalidad. En esta sección encontrarás piezas que revolucionarán cualquier terraza, tanto interior como exterior. También encontrarás productos de la colección Splash! o Collective, con tejidos específicos para Open Air.

Elegance, comfort, and personality. In this section, you'll find pieces that will elevate any terrace, whether indoors or out. You'll also discover items from the Splash! and Collective collections, featuring fabrics specially designed for Open Air.

Collective

Funcionalidad, resistencia y distinción. Los productos Collective combinan diseños originales y materiales especialmente resistentes que los hacen ideales para espacios comunes, hoteles y *coworking*.

Functionality, durability, and style. The Collective products feature original designs and high-resistance materials, making them perfect for shared spaces, hotels, and co-working areas.

Lab

Lab es la sección donde la creatividad y la imaginación toman forma. Una sección experimental donde encontrarás piezas únicas de moda, decoración y más. Una apuesta de OGO por la diversificación, con propuestas originales, innovadoras y sostenibles.

Lab is where creativity and imagination take shape. An experimental section featuring unique pieces in fashion, décor, and beyond. It's OGO's way of embracing diversification with original, innovative, and sustainable designs.

Bali

💧 Splash!



Designed by OGO Furniture

Take me to paradise

Una escapada a Bali sin salir del salón. El paraíso es cualquier espacio con esta pieza. Minimalista y elegante, encaja a la perfección tanto en interiores como en exteriores. Bali, con sus formas relajadas, es un viaje para los sentidos.

A getaway to Bali without leaving your living room. Paradise is anywhere with this piece. Minimalist and elegant, it fits seamlessly into both indoor and outdoor spaces. Bali, with its relaxed design, is a journey for the senses.



On pages 14-17, Bali XXL in Agora 3D Mustard, Bali XL in White, Pillow in Agora 3D White.



Pillow, tu mejor aliado

No es solo un cojín, es tu mejor aliado para llevar la comodidad al siguiente nivel. Con un relleno ergonómico que se adapta a ti, convierte tu Bali y Llit Out en puro placer.

Pillow, your ultimate ally in comfort

Not just a cushion—it's your go-to for next-level comfort. With ergonomic filling that molds to you, make your Bali and Llit Out feel like pure bliss.

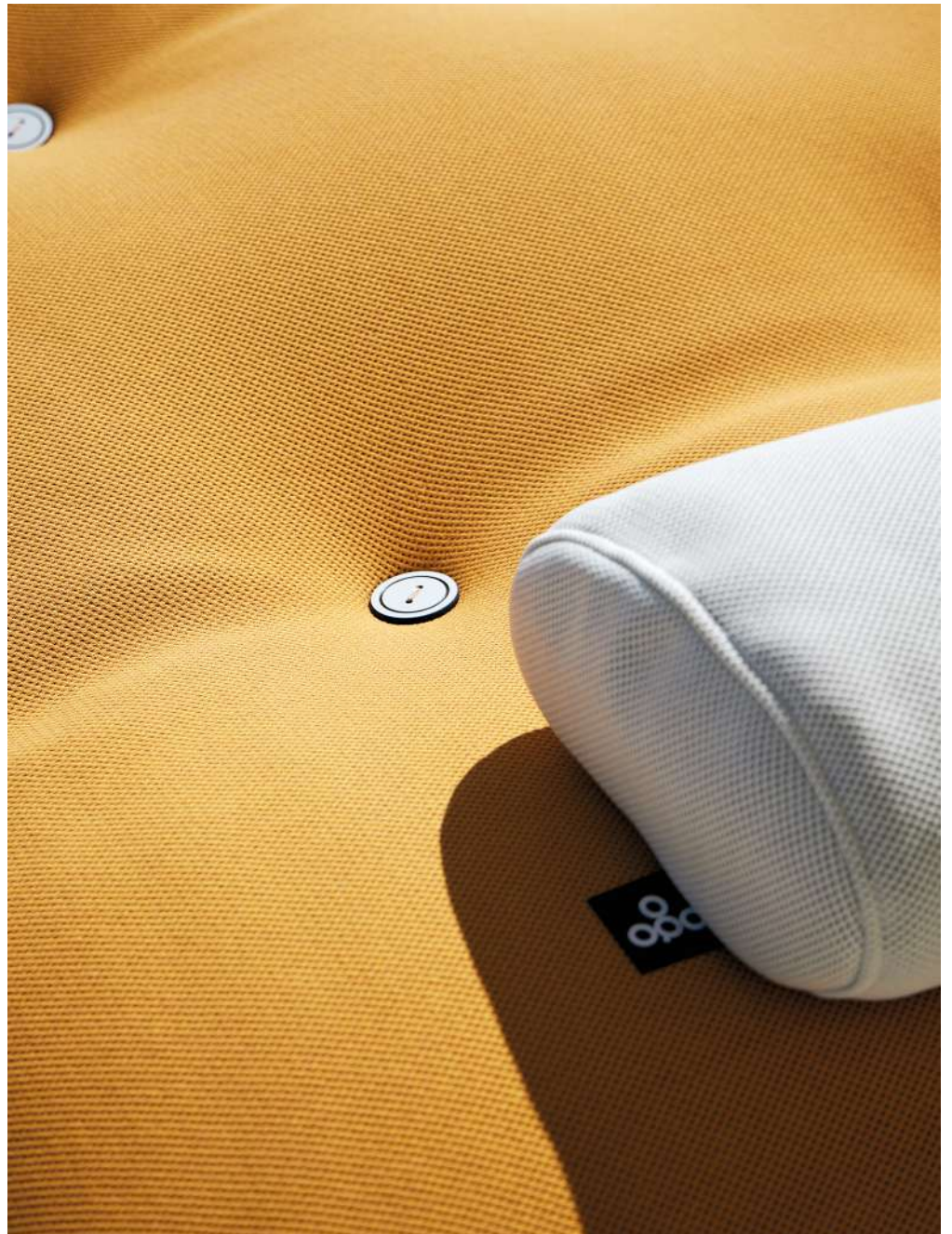

Llit Out

💧 Splash!



Designed by OGO Furniture

The ultimate puzzle piece

Elegante sencillez y versatilidad. Una pieza camaleónica que da un toque de gracia a cualquier mobiliario. El Llit cambia de forma para adaptarse a lo que necesitas. Juega, combina, cambia, hazla tuya. Dentro o fuera de la piscina, dentro o fuera del hogar, es tan ligero que puedes llevarlo a donde quieras.

Elegant simplicity and versatility. A chameleon-like piece that adds a touch of charm to any setting. Llit changes its shape to adapt to your needs. Play, combine, rearrange, make it your own. Whether in or out of the pool, indoors or outdoors, its lightweight design allows you to take it wherever you need it.





Lit Out in Agora 3D Blue and White,
Tote Bag in Agora 3D Blue.



María

💧 Splash!



Designed by OGO Furniture

Our very own María Biscuit

María, con su original diseño en forma de disco, es el *perfect match* de cualquier rincón. Una pareja infalible, como la leche y las galletas. Concebida como punto de fuga de los espacios grises, esta pieza dará vida al mobiliario. Confort y elegancia se unen para crear a la compañera perfecta para tu día a día.

María, with its unique disc-shaped design, is the perfect match for any corner. An unbeatable pair, like milk and cookies. Designed to bring a splash of colour to dull spaces, this piece will breathe life into your furniture. Comfort and elegance come together to create the ideal companion for your everyday life.





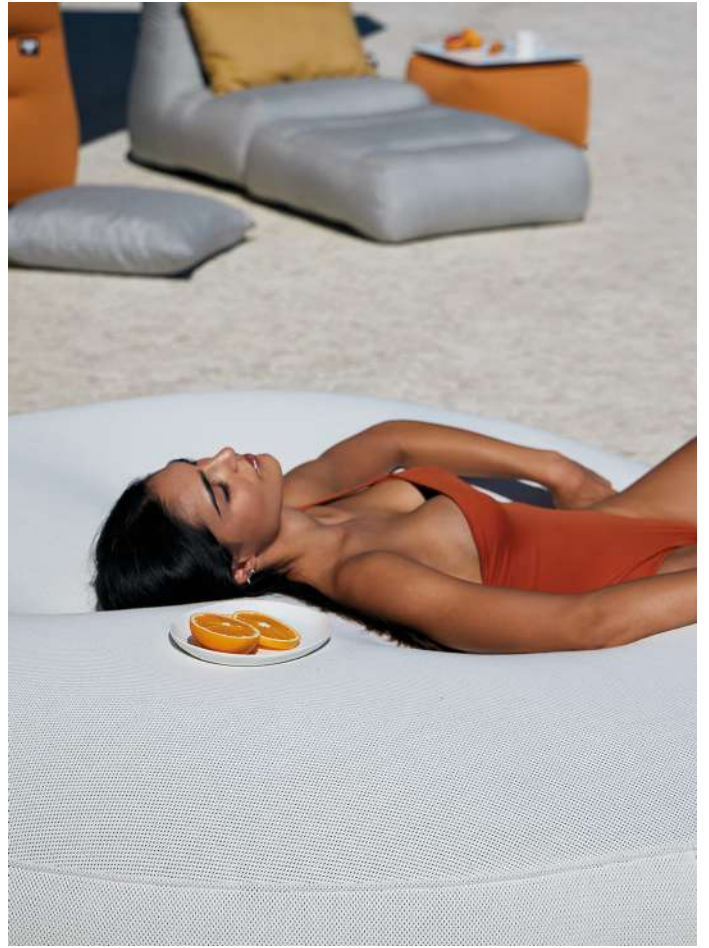

Starfish

💧 Splash!



Designed by Nacho Timón

The sea always by your pool

Deja que Starfish llene de mar cualquier espacio. Nuestra estrella brilla a ras de suelo y llena de vida el entorno. Disponible en tres tamaños y en una amplia gama de colores, es tan versátil como única. Úsala como asiento compartido, respaldo cómodo o deja que flote en tu piscina. No es de extrañar que Starfish sea uno de nuestros productos estrella.

Let Starfish fill any space with the sea. Our Starfish shines at ground level and brings the environment to life. Available in three sizes and a wide range of colours, it's as versatile as it is unique. Use it as a shared seat, a comfortable backrest or let it float in your pool. No wonder Starfish is one of our star products.

Starfish S and Starfish XL in Agora 3D White,
Starfish XXL in Agora 3D Anthracite.



Hidden Hill Naxos, Greece

Starfish XL in Agora 3D Savanne.





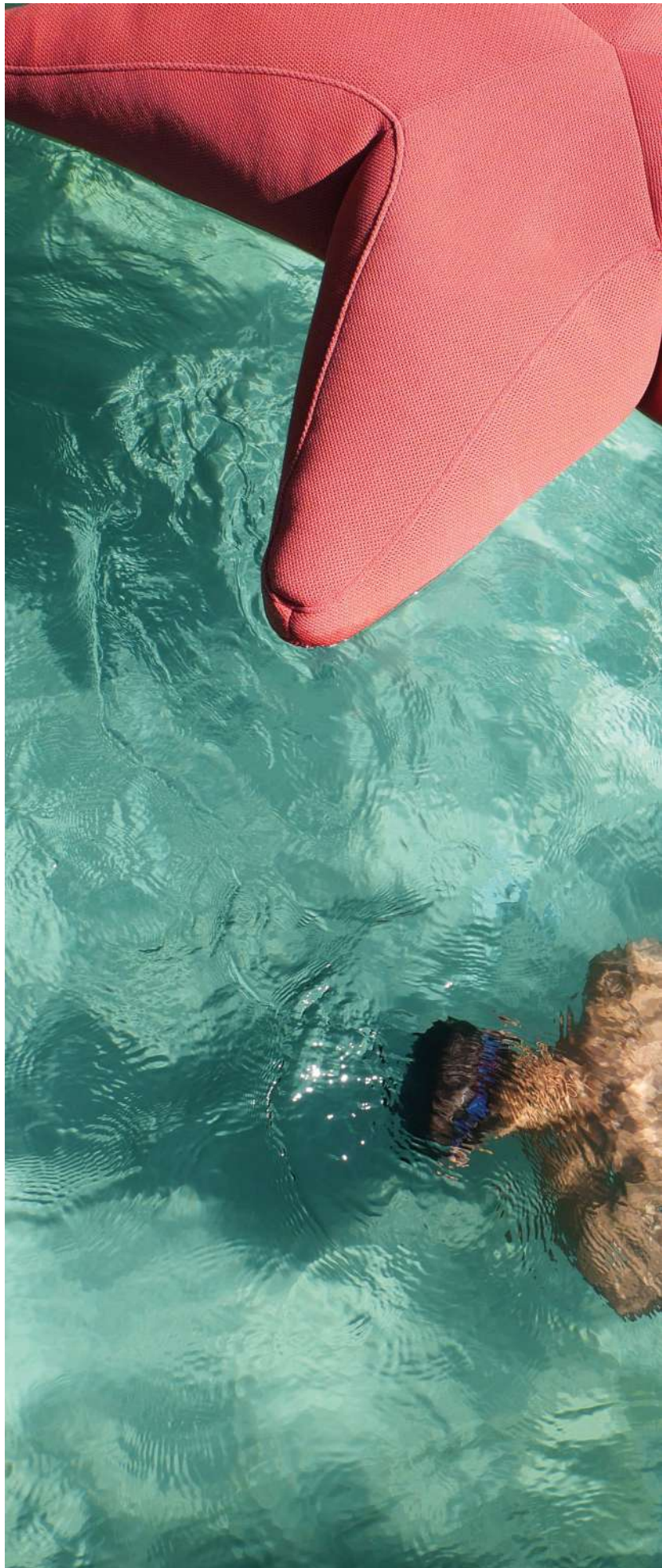

Casa 1876, Portugal

Starfish XL in Agora 3D Coral
and in Agora 3D Mineral.



Sit Pool

💧 Splash!

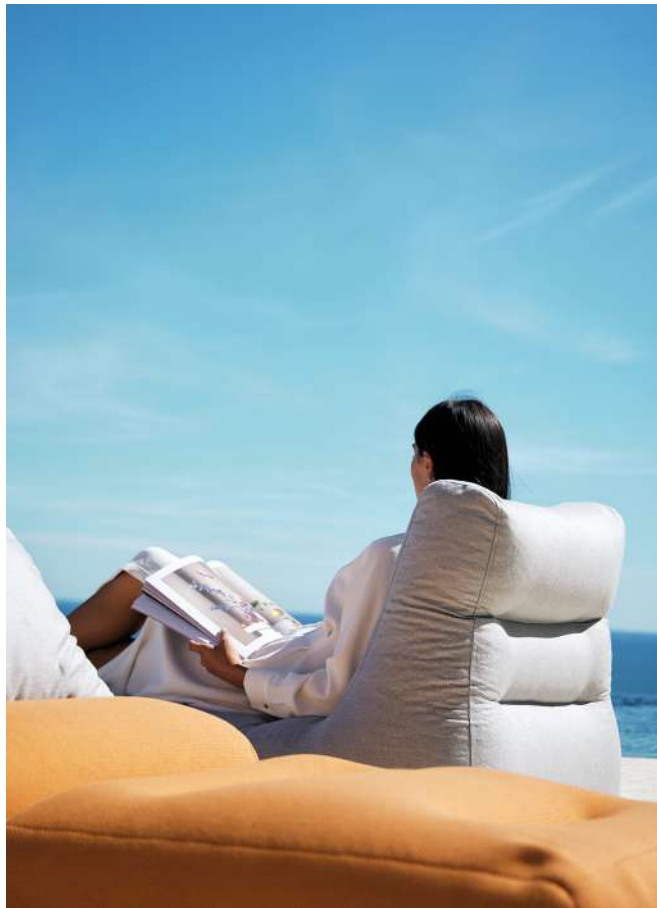

Designed by OGO Furniture

Comfort your mood

Sit Pool fue diseñado originalmente como *chaise longue* para exteriores, pero su versatilidad va mucho más allá. Su diseño minimalista y confort excepcional lo hacen perfecto también para espacios interiores. Una combinación ideal de estilo y funcionalidad, Sit Pool es un claro ejemplo del enfoque adaptable del diseño de OGO.

Sit Pool was originally designed as an outdoor chaise longue, but its versatility goes far beyond that. Its minimalist design and exceptional comfort make it just as suited for indoor spaces. A perfect blend of style and functionality, Sit Pool is a true example of OGO's adaptable approach to design.

On the current page, Sit Pool 1 seat in Agora 3D Green and in Agora 3D White.





Sit Pool 1 seat in Agora 3D Mustard and in Heritage Ash, Cushion XL in Heritage Ash, Puf Pool Table in Agora 3D Mustard.



Sit Pool Sunbed



Designed by OGO Furniture

The ultimate poolside sunbathing

OGO da un paso más hacia el sector Contract, diseñando la Base expresamente para elevar el Sit Pool haciendo que este, además de ser un producto Splash! y Open Air, se integre en el espacio Collective.

OGO takes one more step towards the Contract sector, designing the Base specifically to elevate the Sit Pool, ensuring that, apart from being a Splash! and Open Air product, it can be integrated into the Collective space.



Sit Pool Sunbed in Agora 3D Green
and Puf Pool Table in Agora 3D Green.



On the current page, Sit Pool Sunbed
in Agora 3D Savanne.





Puf Pool Table, el complemento perfecto para tu descanso al sol

Ten siempre todo a mano para disfrutar del sol con Puf Pool Table. El compañero perfecto para Sit Pool y para ti. ¡Haz un *super match* con el confort!

Puf Pool Table, the perfect match for sun-drenched relaxation

Always have everything at hand to enjoy the sun with the Puf Pool Table—your perfect poolside companion. Make comfort your perfect match!



Don Out Collection

💧 Splash!



Designed by Nacho Timón

Don Out worry, be happy

Don Out worry, be happy. Más que un producto es un modo de vida. Una colección de piezas únicas con un diseño que no deja a nadie indiferente. Descubre los accesorios disponibles y descubre las infinitas posibilidades del donut menos comestible pero más versátil que existe.

Don Out worry, be happy. It's more than just a product—it's a way of life. A collection of one-of-a-kind pieces with a design that stands out. Check out the accessories and explore the endless possibilities of the least edible, yet most versatile, donut you'll ever find.

Photography by Solara Living

On the previous page, Don Out Table
in Agora 3D White. Don Out L in
Agora 3D Green.



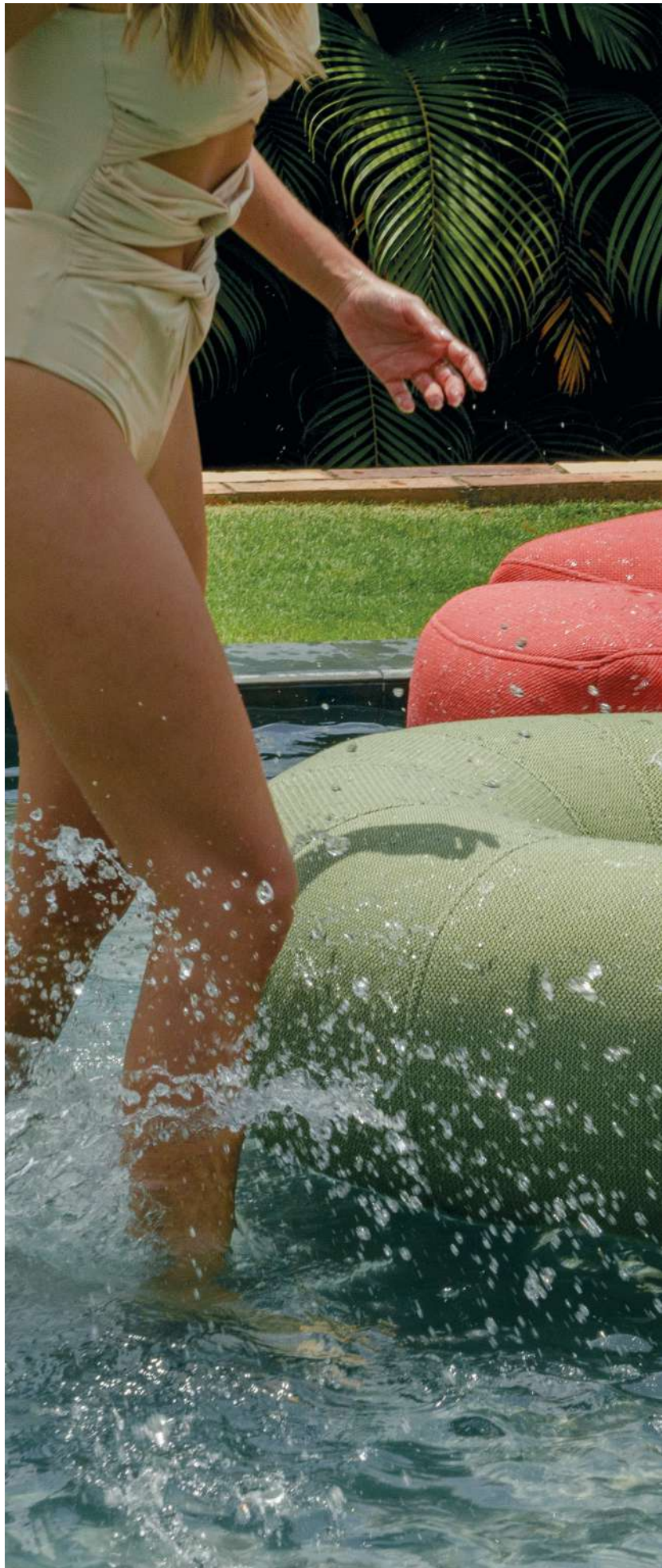







Bloom Out



Don Out designed by Nacho Timón
Bloom Base designed by Adán D. Modesto

A blooming twist on one of our flagship products

El complemento perfecto para el Don Out L llega para ampliar su versatilidad. Ahora, con un innovador diseño de Adán D. Modesto inspirado en la delicadeza de las flores, nace un cómodo sofá mecedor: Bloom Out.

The perfect complement to the Don Out L arrives to extend its versatility. Now, With a fresh design by Adán D. Modesto, inspired by the delicacy of flowers, a comfortable rocking sofa is born: Bloom Out.

Don Out L in Agora 3D Coral,
Bloom Base in Pearl white finish.



**¡Nuevo color!**

Empieza este nuevo año con tus productos OGO en un nuevo color de la gama Agora 3D: Petrol. ¡Tan azul como el cielo y el mar Mediterráneo!

New colour!

Start this new season with your OGO products in our new colour for Agora 3D: Petrol. Just as blue as the Mediterranean sky and sea!

Don Out L in Agora 3D Petrol and White, Bloom Base in Pearl white finish, 2 Cactus Base: Cactus XXL in Agora 3D Sand and Cactus XL in Agora 3D White.



Flower

💧 Splash!



Designed by Nacho Timón
2024 ADCV Silver Award, Outdoor Furniture

Colour & comfort in full bloom

Es hora de florecer. Con su diseño de cinco pétalos, Flower trae la primavera a cualquier espacio. Nacho Timón creó esta original y versátil pieza que acapara la atención allí donde va. Perfecta para sentarse a conversar o tumbarse a tomar el sol. Además, los modelos XL y XXL cuentan con un pistilo que puede usarse de almohada.

It's time to blossom. With its five-petal design, Flower brings a sense of spring to any space. Created by Nacho Timón, this unique and versatile piece is sure to stand out wherever it goes. Perfect for relaxing in the sun or catching up with friends. Plus, the XL and XXL models feature a pistil that works as a pillow.



On the previous page Flower Sin
Agora 3D White.







Flower S in Agora 3D Mustard,
Don Out Sofa in Agora 3D Sand.

Flower S in Agora 3D Coral and
White, Flower L in Agora 3D White,
Flower XL in Agora 3D Mustard
and Green, Flower XXL in
Agora 3D Savanne.





Flower S in Agora 3D Savanne and Anthracite. Flower L in Agora 3D Savanne. Flower XL in Agora 3D Sand and White. Flower XXL in Agora 3D White and Mustard.



Lola G



Designed by Ana Llácer

Be bold, be Lola

Lola G llega pisando fuerte a cualquier lugar. Fiel a su nombre fuerte y distintivo, esta pieza destaca por su diseño minimalista y versátil. Disponible en varios colores, Lola G fue creada para aportar un toque de frescura a salas de reuniones, *lounges* y espacios de juego.

Lola G makes a bold entrance wherever it goes. True to its strong and distinctive name, this piece stands out with its minimalist design and versatility. Available in a range of colours, Lola G was made to bring a touch of freshness to meeting rooms, lounges, and play areas.





Lola G in Batyline White, Zinc, Karité, Safran and Salvia.



Perla



Designed by OGO Furniture

A classic that never grows old

Dicen por ahí que las Perlas son un clásico que siempre está de moda. Con esa idea en mente, en OGO hemos creado una pieza atemporal, sencilla y discreta. Perlas de color para engalanar cualquier espacio. Disponible en una amplia gama de tejidos y tonalidades para la sección Open Air. En caso de usarse como mesa o en zona común de alto tránsito, se recomienda la opción Compacta, disponible en tamaño L.

They say that pearls are a timeless classic that's always in fashion. With that in mind, at OGO, we have created a timeless, simple, and understated piece. Colourful pearls to brighten up any space. Available in a wide range of fabrics and shades for the Open Air collection. If used as a table or in a high-traffic common area, we recommend the Compact option, available in size L.



In the previous page, Perla L
in Silvertex Cobre.

In the current page, Perla Compact L
in Silvertex Cobre.

Mandarina



Designed by Nacho Timón

A mediterranean snack

A esta Mandarina no puedes hincarle el diente pero provocará una explosión de alegría allí donde la pongas. Todo el sabor, el color y la vida del Mediterráneo en una pieza fresca, desenfadada y cautivadora. Disponible en relleno ligero de PES o Compacta, en distintos tamaños y colores para darle un mordisco a tu imaginación y probar un sinfín de combinaciones.

You can't take a bite out of this Tangerine, but it's sure to bring a burst of joy wherever you place it. Packed with the vibrant colour, energy, and charm of the Mediterranean, this fresh and playful piece is designed to captivate. Available with lightweight PES filling or in the durable Compact option, it comes in a range of sizes and colours, letting you mix, match, and create endless combinations.

On the previous page, Mandarin
Compact XXL in Silvertex Cobre.

On the current page, Mandarin XXL
in Silvertex Ice.



Duna Collection



Designed by OGO Furniture

**An oasis in which
time stands still**

Inspirada en la belleza cambiante y las formas efímeras de las dunas pero con el estilo atemporal y la calidad duradera que caracteriza a OGO. Nuestra Duna fluye y se convierte en tumbona o asiento en función de tus necesidades. Ideal para espacios comunes, la terraza o la piscina.

Inspired by the ever-changing beauty and fleeting shapes of dunes, but with the timeless style and lasting quality that define OGO. Our Duna flows effortlessly, transforming into a lounger or a seat to suit your needs. Perfect for shared spaces, terraces, or by the pool.



On the previous page, Duna Sunlounger M in Kantha Green. Duna Table L in Kantha Green.

On the current page, Duna Sunlounger M in Kantha Taupe.



Igual que las dunas, nuestro producto cambia, se transforma, se adapta a ti.

Just like the dunes, this piece changes, flows, transforms and adapts to you.





Duna Sunlounger M in Kantha Taupe, Duna Sunlounger M in Kantha Orange, Duna Puf XL in Kantha Orange.

Duna Sunlounger L in Kantha Taupe, Duna Table L in Kantha Taupe.



On the current page, Duna
Sunlounger L in Heritage Sky,
Duna Puf XL in Heritage Papyrus.

On the next page, Duna Table L in
Agora 3D Green.



Duna Puf, confort que se adapta a ti

Mucho más que pufs, son piezas clave del confort. Duna Puf XL extiende la experiencia de Duna Sunlounger M, convirtiéndola en una tumbona extra grande. El Duna Table L, siempre tan versátil, se adapta como asiento, reposapiés o mesa auxiliar.

Duna Puf, the shape of comfort

They are more than just poufs, they are key pieces of comfort. Duna Puf XL expands the Duna Sunlounger M experience, turning it into an extra-large lounger. The ever-so-versatile Duna Table L adapts itself as a seat, footrest or as a side table.



Handcrafted with OGO Furniture is born from the Mediterranean *care* in Valencia

En OGO, la pasión
está en cada detalle

Nos enorgullece crear productos originales con un valor añadido. En nuestro taller, cada diseño cobra vida con dedicación, cuidando cada detalle para reflejar nuestra pasión por la artesanía y lo bien hecho.

Al elegir OGO, no solo llevas un producto a casa, sino también una parte de nuestra filosofía: amor por la calidad, el diseño, el entorno y lo auténtico. Llévate el encanto del Mediterráneo a casa con nosotros.

At OGO, passion
is in every detail

We take pride in creating original products with added value. In our workshop, every design comes to life with dedication, ensuring that each detail reflects our passion for craftsmanship and excellence.

When you choose OGO, you're not just bringing home a product; you're embracing a part of our philosophy: a love for quality, design, environment and authenticity. Bring the charm of the Mediterranean home with us.

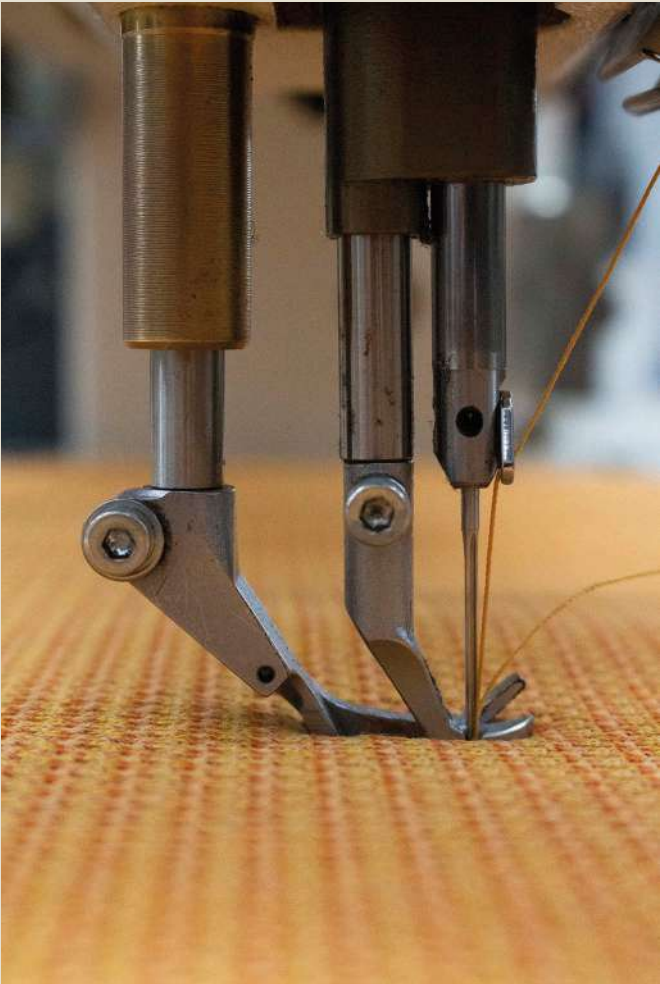

Tejidos cuidadosamente seleccionados para ofrecer un tacto suave y una durabilidad excepcional, incluso en condiciones de altas temperaturas. Trabajamos con marcas prestigiosas que aportan confianza y reflejan nuestro compromiso con la excelencia.

Fabrics carefully selected to offer a soft touch and exceptional durability, even in high temperature conditions. We work with prestigious brands that inspire confidence and reflect our commitment to excellence and craftsmanship.

**Telas de alta calidad
con trabajo artesanal**

En OGO, seleccionamos cuidadosamente los tejidos para satisfacer las necesidades específicas de cada uno de nuestros productos. Para la línea Collective, optamos por tejidos Trevira por su resistencia y durabilidad. En Open Air, priorizamos tejidos resistentes al agua, ideales para enfrentar las inclemencias del tiempo. Para Splash!, buscamos un material único en el que el agua es absorbida y retenida momentáneamente, permitiendo que luego se libere de forma natural.

**High-end fabric
with artisan work**

At OGO, we carefully select fabrics to meet the specific needs of each of our products. For the Collective line, we choose Trevira fabrics for their high resistance and durability. For Open Air, we prioritize water-resistant fabrics, ideal for withstanding the elements. For Splash, we seek a unique material that absorbs and temporarily retains water, allowing it to naturally release later.



Materials that reflect quality and dedication



Take the Mediterranean everywhere

Las Tote Bags de OGO son la combinación perfecta de estilo y funcionalidad, pensadas para acompañarte a donde sea. Hechas con nuestro tejido característico, estas bolsas son tan versátiles como elegantes. Así como nuestras piezas complementan tu espacio, nuestras Tote Bags complementan tu vida.

OGO's Tote Bags are the perfect blend of style and functionality, designed to accompany you wherever you go. Crafted with our signature fabric and a unique, elegant design, these bags are as versatile as they are stylish—just like our furniture complements your space, our tote bags complement your life.



On the previous page, Tote Bag in
Agora 3D Mustard.

On the current page, Tote Bag in
Agora 3D Anthracite.



On the next page, Tote Bag in Agora
3D Green. Lola G in Batyline Zinc,
Salvia, Safran, Karité and White.





A round colourful touch of fun and comfort

Un punto y aparte en la decoración de tu hogar. Nuestro Dot Cushion aportará puntos de color para llenar de vida el espacio, tanto en interior como en exteriores. Disponible en una gran variedad de tonos, combina dos telas de la colección Ágora 3D y encuentra el punto exacto de color que funcione contigo.

A highlight in the decoration of your home. Our Dot Cushion will bring a spot of colour to bring your space to life, both indoors and outdoors. Available in a wide variety of colours, combine two fabrics from the Agora 3D collection and find the exact combination of colour that works for you.



On the previous page, Dot Cushion in Agora 3D Mustard & Mineral, and Green & Mustard.

On the current page, Dot Cushion in Agora 3D Anthracite & Mustard, Green & Mustard and Petrol & Savanne.





Cactus

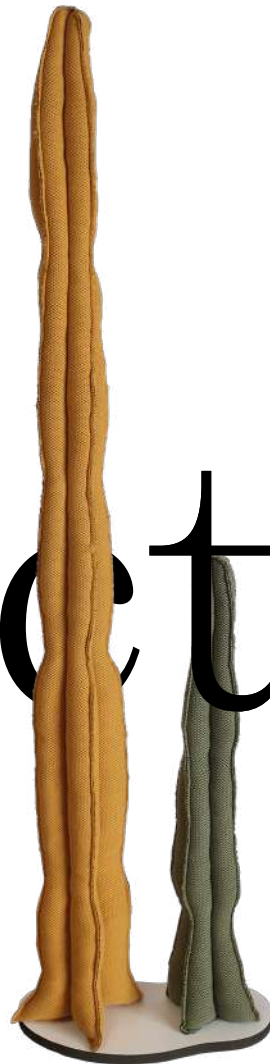

Art that endures, design that inspires

Este Cactus es una auténtica maravilla: no pincha, no necesita agua, nunca se marchita y resiste bien el sol y la lluvia. Perfecto para añadir estilo a espacios abiertos, es mucho más que una decoración.

¿Estás listo para llevar a casa un Cactus que siempre esté en su mejor momento?
¡Hazlo parte de tu espacio!

This Cactus is a true marvel: it doesn't prick, doesn't need water, never wilts, and stands strong against the sun and rain. Perfect for adding style to open spaces, it's much more than a decorative piece—it's the element that turns any corner into a magical or vibrant garden of colours.

Ready to bring home a Cactus that's always at its best? Make it part of your space today!



On the previous page, 2 Cactus Base with Cactus XXL in Agora 3D Savanne and Cactus L in Agora 3D Green.

On the current page, 3 Cactus Base with Cactus L in Agora 3D Green, Cactus XL in Agora 3D Anthracite and Cactus XXL in Agora 3D Mustard.

One step closer to a greener future

Reduce your carbon footprint by 30%

We use BIOPS filling, a material made from plastic waste and plant-based leftovers





**BIOUS filling,
eco-friendly comfort**

En OGO, estamos comprometidos con la sostenibilidad y con el respeto a la naturaleza que nos inspira. Por eso utilizamos BIOUS, un relleno único hecho a partir de biomasa extraída de restos vegetales y residuos. Estas pequeñas perlas representan un paso hacia un futuro más sostenible. Al elegir este material ecológico, seguimos nuestro camino para crear diseños que son tan respetuosos con el medio ambiente como lo son contigo.

At OGO, we are committed to sustainability and to respecting the nature that inspires us. That's why we use BIOUS, a unique filling made from biomass extracted from plant residues and waste. These tiny beads represent a step towards a more sustainable future. By choosing this eco-friendly material, we continue our journey to create designs that are as kind to the environment as they are to you.



Esta funda no es solo un embalaje; es una extensión de nuestro compromiso con la *calidad* y la *experiencia* que mereces. Además, es perfecta para guardar el producto en las temporadas de invierno, eso sí, ¡completamente seco!

This cover is not just packaging; it's an extension of our commitment to quality and the experience you deserve. It is also perfect for storing the product in the winter seasons, but please note that the product must be completely dry!

Los detalles
importan

En OGO, cada detalle cuenta, desde que realizas tu compra hasta que tu pieza llega a tus manos. Nuestros productos están embalados con esmero, y cada pieza llega en una funda de alta calidad que garantiza que llegue en perfectas condiciones. No es solo un embalaje, es el reflejo de nuestro compromiso con la calidad, la artesanía y la experiencia que mereces.

Every detail
matters

At OGO, every detail matters, from the moment you place your order to the moment your piece arrives. Our products are packaged with love and care, and each piece comes in a high-quality protective cover that ensures it reaches you in perfect condition. It's not just packaging—it's a reflection of our commitment to quality, craftsmanship, and the experience you deserve.

Technical Sheets

Meet our catalogue one by one and explore the *possibilities* of the fabrics, colours & fillings.

Bali p.14

Bali XL

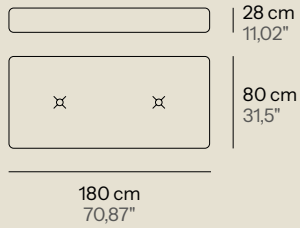

Peso Weight 7 Kg 15,43 lb
 Volumen Volume 0,35 m³

Bali XXL

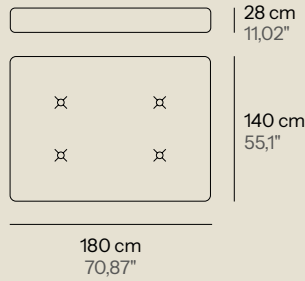

Peso Weight 9 Kg 19,84 lb
 Volumen Volume 1,05 m³

Tejidos disponibles Available fabrics

Agora 3D — G1

Splash!



Silvertex — G2



Heritage — G4



Elios — G4



Kantha (Trevira) — G5



Opciones de relleno para gama Agora 3D. Filling options for Agora 3D fabric range.

100% BIOPS PES Filling

Compuesto por perlas de biomasa obtenidas de restos vegetales. Ligero y resistente. Para productos de piscina.

Composed of biomass beads obtained from plant waste. Lightweight and resistant. Suitable for pool use.

Opciones de relleno para otros tejidos. Filling options for other fabrics.

Mixture (70% shredded foam & 30% BIOPS PES)

Mezcla que combina confort y sostenibilidad. Ideal para exteriores, no apto para piscina.

A mixture that brings comfort and sustainability. Ideal for outdoor use, not suitable for pool use.

Lit Out p.18

Opened

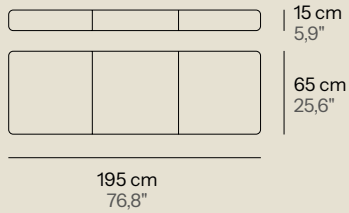

Closed

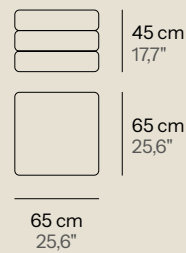

Peso 3 Kg
Weight 6,61 lb

Volumen 0,28 m³
Volume

Tejidos disponibles
Available fabrics

Agora 3D – G1

 Splash!



Opciones de relleno
Filling options

100% BIOPS PES Filling

Compuesto por perlas de biomasa obtenidas de restos vegetales. Ligero y resistente. Para productos de piscina.

Composed of biomass beads obtained from plant waste. Lightweight and resistant. Suitable for pool use.

María p.22

María XL

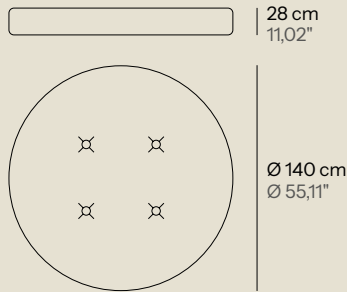

Peso 11 Kg
Weight 24,25 lb

Volumen 0,83 m³
Volume

María XXL

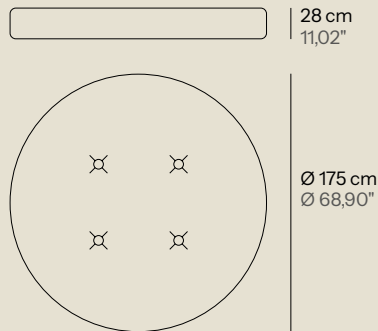

Peso 12 Kg
Weight 26,46 lb

Volumen 1 m³
Volume

Tejidos disponibles para ambos tamaños.
Available fabrics for both sizes.

Agora 3D — G1

Splash!



Tejidos disponibles para María XL.
Available fabrics for María XL.

Silvertex — G2



Heritage — G4



Elios — G4



Kantha (Trevira) — G5



Opciones de relleno para gama Agora 3D.
Filling options for Agora 3D fabric range.

100% BIOPS PES Filling

Compuesto por perlas de biomasa obtenidas de restos vegetales.
Ligero y resistente. Para productos de piscina.

Composed of biomass beads obtained from plant waste.
Lightweight and resistant.
Suitable for pool use.

Opciones de relleno para otros tejidos.
Filling options for other fabrics.

Mixture (70% shredded foam & 30% Biops PES)

Mezcla que combina confort y sostenibilidad. Ideal para exteriores, no apto para piscina.

A mixture that brings comfort and sustainability. Ideal for outdoor use, not suitable for pool use.

Starfish p.26

Starfish S

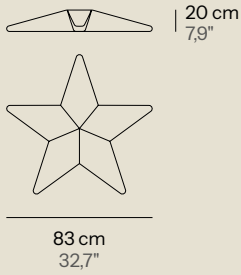

Peso 2,4 Kg
Weight 5,29 lb

Volumen 0,09 m³
Volume

Starfish XL

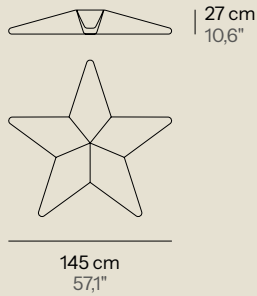

Peso 6 Kg
Weight 13,23 lb

Volumen 0,5 m³
Volume

Starfish XXL

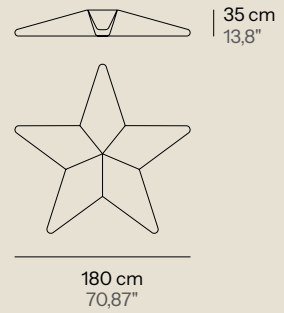

Peso 7,3 Kg
Weight 16,09 lb

Volumen 1,01 m³
Volume

Tejidos disponibles
Available fabrics

Agora 3D – G1

Splash!



Opciones de relleno
Filling options

100% BIOPS PES Filling

Compuesto por perlas de biomasa obtenidas de restos vegetales. Ligeroy resistente. Para productos de piscina.

Composed of biomass beads obtained from plant waste. Lightweight and resistant. Suitable for pool use.

Sit Pool p.32

Sit Pool 1 Seat (SP01)

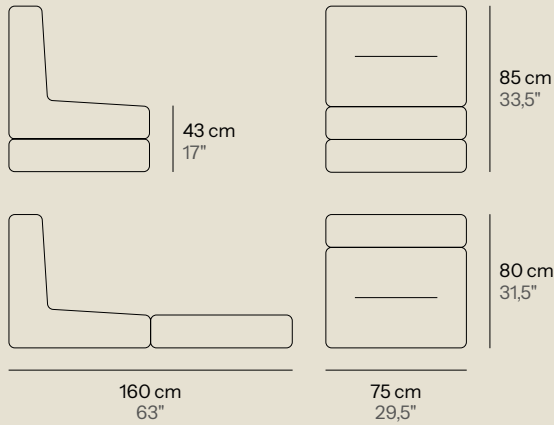

Sit Pool 2 Seats (SP02)

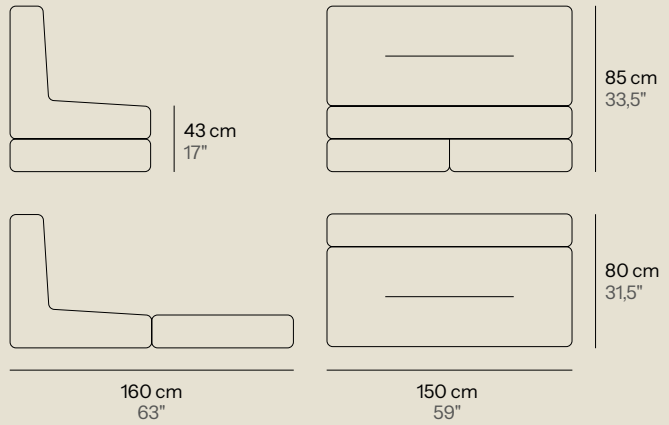

Peso Weight 7,6 Kg 16,76 lb
 Volumen Volume 0,53 m³

Peso Weight 15 Kg 19,84 lb
 Volumen Volume 0,86 m³

Tejidos disponibles Available fabrics

Agora 3D — G1

Splash!



Silvertex — G2



Heritage — G4



Elios — G4



Kantha (Trevira) — G5



Relleno para Agora 3D Filling for Agora 3D

100% BIOPS PES Filling

Compuesto por perlas de biomasa obtenidas de restos vegetales. Ligero y resistente. Para productos de piscina.

Composed of biomass beads obtained from plant waste. Lightweight and resistant. Suitable for pool use.

Relleno para otros tejidos Filling for other fabrics

Mixture (70% shredded foam & 30% BIOPS PES)

Combina confort y sostenibilidad. Para exteriores, no apto para piscina.

Brings comfort and sustainability. Outdoors, not suitable for pool use.

Sit Pool Base p.36

Sit Pool Base

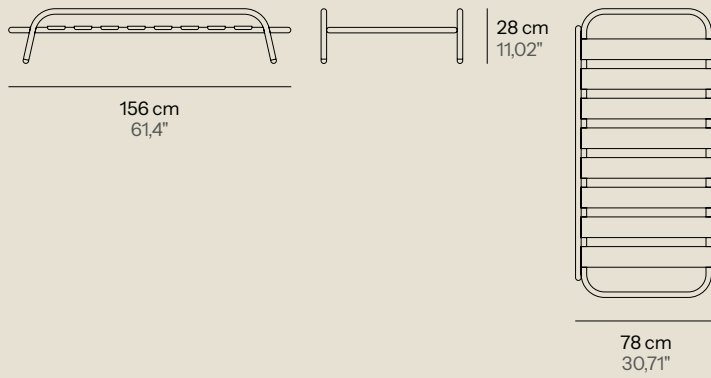

Peso	7,1 Kg
Weight	15,65 lb
Volumen	0,38 m ³
Volume	

Acabados
Finishes

Aluminio
Aluminium



Blanco perla
Pearl white

Otras especificaciones
Other specifications

Producto hecho de aluminio con acabado de pintura texturizada para exteriores en el color blanco perla.

Product made of aluminium with texturized outdoor painting in pearl white.

Contactar con el equipo de OGO para explorar otras opciones de colores en el pedido (a partir de 20 unidades).

Contact the OGO team to explore other colour options when ordering (from 20 units).

Este producto solamente complementa el Sit Pool de una plaza (SP01). La Sit Pool Base con el SP01 forman Sit Pool Sunbed.

This product only complements our Sit Pool 1 seat (SP01). The Sit Pool Base paired with the SP01 form the Sit Pool Sunbed.

Don Out Collection p.42

Don Out L/XL



Size L
30 cm
11,81"

Size XL
35 cm
13,78"

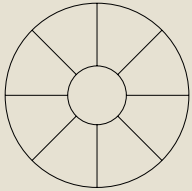

Size L
Ø 98 cm
Ø 38,58"

Size XL
Ø 110 cm
Ø 43,30"

Don Out Table

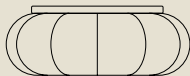

31,5 cm
11,81"

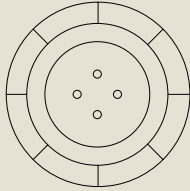

Ø 98 cm
Ø 38,58"

Table

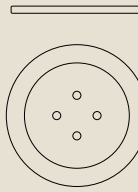

1,5 cm
0,59"

Ø 70 cm
27,56"

Accessory

Don Out Sofa L/XL

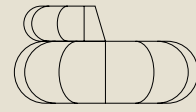

20 cm
7,87"

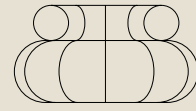

Size L
50 cm
19,69"

Size XL
55 cm
21,65"

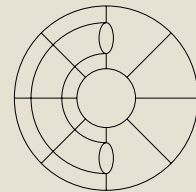

Size L
Ø 98 cm
Ø 38,58"

Size XL
Ø 110 cm
Ø 43,30"

Peso L
Weight L

3 Kg
6,61 lb

Volumen L
Volume L

0,43 m³

Peso XL
Weight XL

6 Kg
13,22 lb

Volumen XL
Volume XL

0,51 m³

Peso
Weight

10 Kg
22,05 lb

Volumen
Volume

0,43 m³

Peso
Weight

7 Kg
15,43 lb

Volumen
Volume

0,03 m³

Peso L
Weight L

4 Kg
8,82 lb

Volumen L
Volume L

0,46 m³

Peso XL
Weight XL

7 Kg
15,43 lb

Volumen XL
Volume XL

0,51 m³

Tejidos disponibles Available fabrics

Agora 3D – G1

Splash!



White Sand Mineral Anthracite Mustard Savanne Green Blue Petrol Coral

Opciones de relleno Filling options

100% BIOPS PES Filling

Compuesto por perlas de biomasa obtenidas de restos vegetales. Ligero y resistente. Para productos de piscina.

Composed of biomass beads obtained from plant waste. Lightweight and resistant. Suitable for pool use.

Otras especificaciones Other specifications

Los accesorios se venden por separado, consultar tarifas.

Accessories are sold separately, please consult prices.

El accesorio Table solamente está disponible para el Don Out L.

The Table is only suitable for Don Out L.

Bloom Base

Bloom Out

p.48



97 cm
38,19"

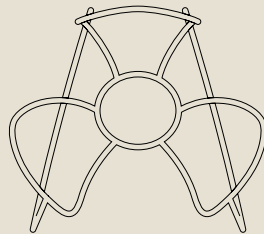

104 cm
40,94"

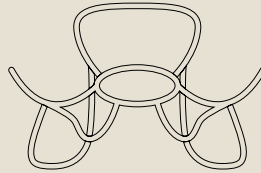

62 cm
24,41"

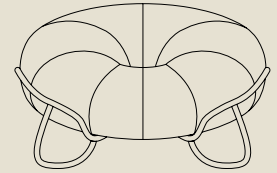

Don Out L + Bloom Base

Peso 6,7 Kg
Weight 14,77 lb

Volumen 0,53 m³
Volume

Acabados
Finishes

Hierro
Iron



Blanco perla
Pearl white

Otras especificaciones
Other specifications

Producto hecho de hierro con acabado de pintura texturizada para exteriores en el color blanco perla. Contactar con el equipo de OGO para explorar otras opciones de colores en el pedido.

Este Bloom Base está diseñado para complementar únicamente el Don Out L.

Product made of iron with texturized outdoor painting in pearl white. Contact the OGO team to explore other colour options when ordering.

This Bloom Base is designed to complement the Don Out L only.

Flower p.52

Flower S

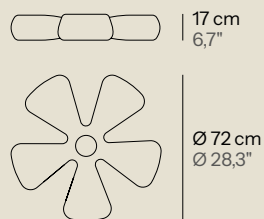

Flower L

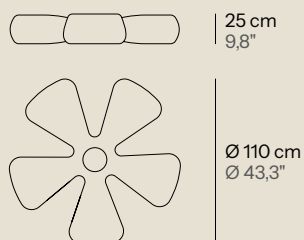

Flower XL

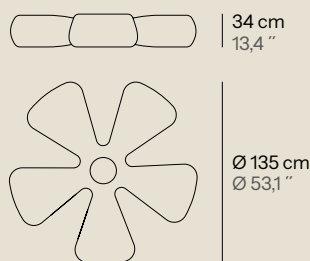

Flower XXL

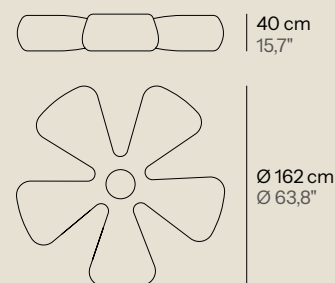

Peso Weight 1,8 Kg 3,97 lb

Volumen Volume 0,09 m³

Peso Weight 3,1 Kg 6,83 lb

Volumen Volume 0,4 m³

Peso Weight 5,2 Kg 11,46 lb

Volumen Volume 0,46 m³

Peso Weight 8 Kg 17,63 lb

Volumen Volume 1,01 m³

Tejidos disponibles Available fabrics

Agora 3D – G1

Splash!



Opciones de relleno Filling options

100% BIOPS PES Filling

Compuesto por perlas de biomasa obtenidas de restos vegetales. Ligero y resistente. Para productos de piscina.

Composed of biomass beads obtained from plant waste. Lightweight and resistant. Suitable for pool use.

Otras especificaciones Other specifications

Pistilo se vende por separado solo para los tamaños XL y XXL, además puede ser en un color diferente para ampliar la personalización del producto.

Pistil is sold separately only for sizes XL and XXL, it can also be in a different colour to extend the customisation of the product.

Lola G p.60

Lola G

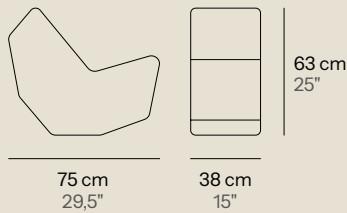

Peso Weight	5 Kg 11,02 lb
Volumen Volume	0,2 m³

Tejidos disponibles Available fabrics

Batylite — G3



Elios — G4



Estructura interior Inner structure

Poliestireno prensado de alta densidad revestido con gomaespuma *dryfeel* de alta calidad.
High density pressed polystyrene covered with high quality dryfeel foam rubber.

El material de esta estructura hace que el producto sea duradero y mantenga su forma en el tiempo, evitando así la deformación.

This structure materials ensure the durability of the product and maintains its shape over time. It avoids deformation.

Otras especificaciones Other specifications

Necesidades de limpieza específicas.
Specific cleaning needs.

Lola G se puede desfundar para su limpieza, sin embargo, dada su dificultad, recomendamos evitar este proceso si no es un caso extremo.

Elimine el exceso de suciedad con papel absorbente, aplique el producto de limpieza sobre la mancha y deje actuar unos minutos. Elimine los residuos con un paño limpio, puede utilizar agua con un poco de presión (no utilice una Kärcher).

El interior hidrófugo es drenable, no absorbe el agua. Dejar secar.

Lola G can be unholstered for its washing, however, given its difficulty, we recommend avoiding this process if it is not an extreme case.

Remove excess dirt with absorbent paper, apply cleaning product on the stain and leave for a few minutes. Remove residue with a clean cloth, you can use water with a little pressure (do not use a Kärcher).

The water-repellent interior is drainable, does not absorb water. Leave to dry.

Perla p.64

Perla L		Perla XL		Perla Compact L	
	38 cm 15"		45 cm 17,7"		Ø 38 cm Ø 15"
	Ø 52 cm Ø 20,6"		Ø 65 cm Ø 25,6"		Ø 49 cm Ø 19,3"
Peso Weight	2 Kg 4,41 lb	Peso Weight	5 Kg 11,02 lb	Peso Weight	6,5 Kg 14,33 lb
Volumen Volume	0,10 m³	Volumen Volume	0,20 m³	Volumen Volume	0,10 m³

Tejidos disponibles para Perla L y Perla XL.
Available fabrics for Perla L & Perla X.

Agora 3D — G1



Heritage — G4



Elios — G4



Tejido disponibles para Perla L, Perla XL y Perla Compact L.
Available fabric for Perla L, Perla XL & Perla Compact L.

Silvertex — G2



Opciones de relleno para tejido Agora 3D.
Filling options for Agora 3D fabric.

100% BIOPS PES Filling

Compuesto por perlas de biomasa obtenidas de restos vegetales. Ligero y resistente. Para zona de piscina, 100 % exterior.

Composed of biomass beads obtained from plant waste. Lightweight and resistant. Suitable for poolside areas, 100% outdoor.

Opciones de relleno para otros tejidos.
Filling options for other fabrics.

Mixture (70% shredded foam & 30% BIOPS PES)

Mezcla que combina confort y sostenibilidad. Ideal para exteriores, no apto para piscina.

A mixture that brings comfort and sustainability. Ideal for outdoor use, not suitable for pool use.

Opciones de relleno para Perla Compact L.
Filling options for Perla Compact L.

High-density, 30 KG/D foam filling

Espuma compacta que garantiza durabilidad y resistencia, manteniendo su forma con el uso. No sumergir en agua. Para interiores y terrazas cubiertas.

Compact foam that guarantees durability and resistance, maintaining its shape over time. For indoor spaces and covered terraces.

Mandarina p.66

Mandarina XL

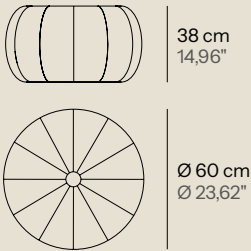

Peso 3 Kg
Weight 6,61 lb

Volumen 0,22 m³
Volume

Mandarina XXL

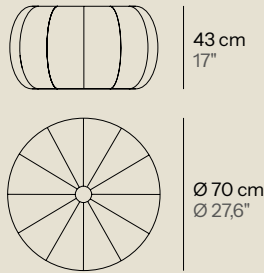

Peso 3,5 Kg
Weight 7,71 lb

Volumen 0,22 m³
Volume

Mandarina Compact XXL

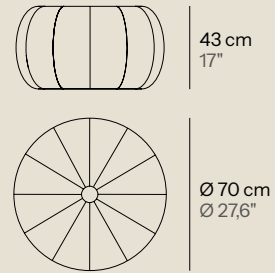

Peso 7 Kg
Weight 15,43 lb

Volumen 0,22 m³
Volume

Tejidos disponibles para Mandarina XL y Mandarina XXL.
Available fabrics for Perla L & Perla X.

Agora 3D – G1



Heritage – G4



Elios – G4



Tejido disponibles para Mandarina XL, XXL y Mandarina Compact XXL.
Available fabric for Mandarina XL, XXL & Mandarina Compact XXL.

Silvertex – G2



Opciones de relleno para tejido Agora 3D.
Filling options for Agora 3D fabric.

100% BIOPS PES Filling

Compuesto por perlas de biomasa obtenidas de restos vegetales. Ligero y resistente. Para zona de piscina, 100 % exterior.

Composed of biomass beads obtained from plant waste. Lightweight and resistant. Suitable for poolside areas, 100% outdoor.

Opciones de relleno para otros tejidos.
Filling options for other fabrics.

Mixture (70% shredded foam & 30% BIOPS PES)

Mezcla que combina confort y sostenibilidad. Ideal para exteriores, no apto para piscina.

A mixture that brings comfort and sustainability. Ideal for outdoor use, not suitable for pool use.

Opciones de relleno para Mandarina Compact XXL.
Filling options for Mandarina Compact XXL.

High-density, 30 KG/D foam filling

Espuma compacta que garantiza durabilidad y resistencia, manteniendo su forma con el uso. No sumergir en agua. Para interiores y terrazas cubiertas.

Compact foam that guarantees durability and resistance, maintaining its shape over time. For indoor spaces and covered terraces.

Duna Collection p.68

Duna Sunlounger M

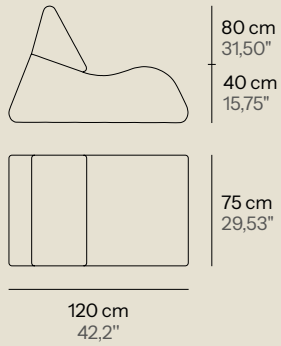

Duna Sunlounger L

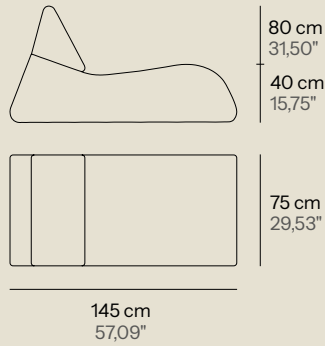

Duna Table L

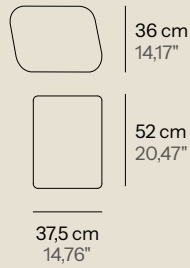

Accessory

Duna Puf XL

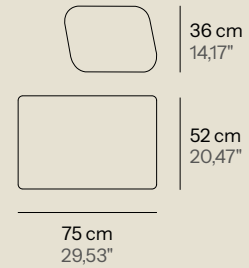

Accessory

Peso 15 Kg
Weight 33,07 lb

Volumen 0,76 m³
Volume

Peso 18 Kg
Weight 39,68 lb

Volumen 0,83 m³
Volume

Peso 3 Kg
Weight 6,61 lb

Volumen 0,07 m³
Volume

Peso 4 Kg
Weight 8,82 lb

Volumen 0,14 m³
Volume

Tejidos disponibles Available fabrics

Agora 3D — G1



Silvertex — G2

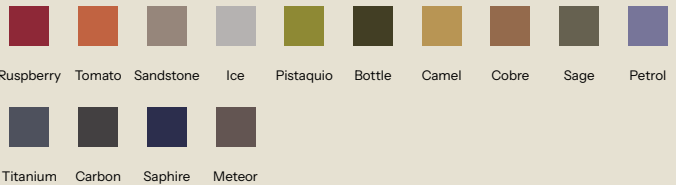

Batylite — G3

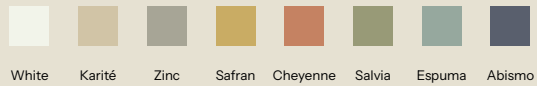

Heritage — G4



Elios — G4



Kantha (Trevira) — G5



Duna Sunlounger M

Opened

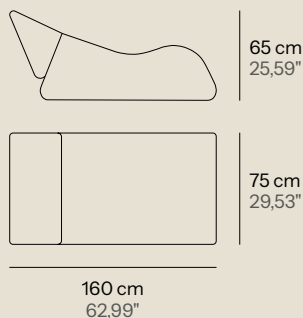

Duna Sunlounger L

Opened

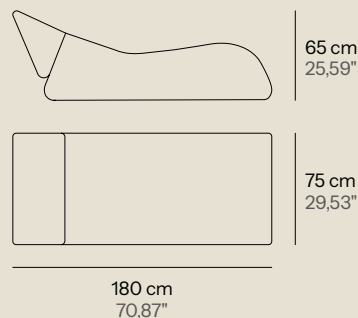

Peso 15 Kg
Weight 33,07 lb

Volumen 0,76m³
Volume

Peso 18 Kg
Weight 39,68 lb

Volumen 0,83 m³
Volume

Opciones de relleno
Filling options

Goma espuma hidrófuga, 25 kg de densidad. DRYFEEL.
Compact foam rubber, 25 KG density. DRYFEEL.

Espuma compacta que garantiza durabilidad y resistencia, manteniendo su forma con el uso. No sumergir en agua. Para interiores y terrazas cubiertas.

Compact foam that guarantees durability and resistance, maintaining its shape over time. For indoor spaces and covered terraces.

Otras especificaciones
Other specifications

Necesidades de limpieza específicas.
Specific cleaning needs.

Duna Collection se puede desenfundar para su limpieza, sin embargo, dada su dificultad, recomendamos evitar este proceso si no es un caso extremo.

Duna Collection can be unholstered for its washing, however, given its difficulty, we recommend avoiding this process if it is not an extreme case.

Elimine el exceso de suciedad con papel absorbente, aplique el producto de limpieza sobre la mancha y deje actuar unos minutos. Elimine los residuos con un paño limpio, puede utilizar agua con un poco de presión (no utilice una Kärcher).

Remove excess dirt with absorbent paper, apply cleaning product on the stain and leave for a few minutes. Remove residue with a clean cloth, you can use water with a little pressure (do not use a Kärcher).

El interior hidrófugo no absorbe el agua. Dejar secar.

The water-repellent interior does not absorb water. Leave to dry.

Tote Bag p.80

Tote Bag

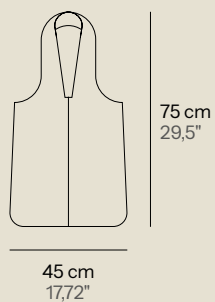

Peso 0,5 Kg
Weight 1,10 lb

Capacidad 10 L
Capacity

Tejidos disponibles
Available fabrics

Agora 3D — G1



Otras especificaciones
Other specifications

Lleva el espíritu del Mediterráneo adónde sea que vayas.

Bring the spirit of the Mediterranean wherever you go.

Este producto fue concebido como una forma de no desperdiciar material y ha acabado convirtiéndose en un producto de nuestro catálogo.

This product was conceived as a way of not wasting material and has become a product in our catalogue.

Lavar en lavadora, no destiñe ni encoge.

Machine washable, won't fade or shrink.

Dot Cushion p.84

Dot Cushion

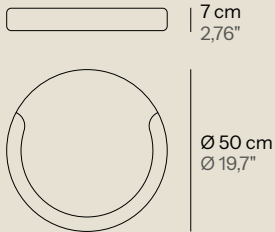

Peso Weight	0,7 Kg 1,54 lb
Volumen Volume	0,04 m ³

Tejidos disponibles
Available fabrics

Agora 3D – G1



Opciones de relleno
Filling options

Goma espuma hifrófuga, 25 kg de densidad. DRYFEEL.
Compact foam rubber, 25 KG density. DRYFEEL.

Espuma compacta que garantiza durabilidad y resistencia, manteniendo su forma con el uso. No sumergir en agua. Apto para zona de piscina, 100% exterior.

Compact foam that guarantees durability and resistance, maintaining its shape over time. Suitable for pool area, 100% outdoor.

Otras especificaciones
Other specifications

Este producto hace uso de dos colores de la gama de tejidos Agora 3D, combinalos como quieras para tener tu Dot Cushion a medida.

Consultar a fabricación para otras opciones para proyectos de interior o bajo cubiertas.

Fácil de desenfundar, lavado a máquina.

This product makes use of two colours from the Agora 3D fabric range, combine them as you wish to have your Dot Cushion made to measure.

Consult the factory for additional options for interior projects or under-deck installations.

Easy to uncover, machine-washable.

Cactus p.88

Cactus L



Peso
Weight 1,5 Kg
3,31 lb

Volumen
Volume 0,04 m³

Cactus XL

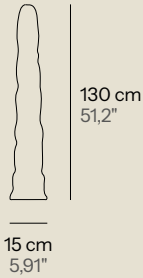

Peso
Weight 2,1 Kg
4,63 lb

Volumen
Volume 0,07 m³

Cactus XXL

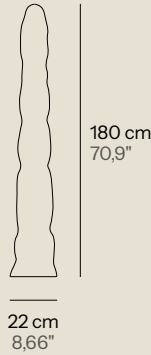

Peso
Weight 2,8 Kg
6,17 lb

Volumen
Volume 0,16 m³

Cactus 2 & 3 Bases

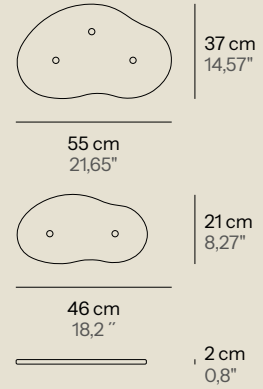

Peso
Weight (2 Cactus) 2 Kg
4,41 lb

Volumen
Volume (2 Cactus) 0,002 m³

Peso
Weight (3 Cactus) 3 Kg
6,61 lb

Volumen
Volume (3 Cactus) 0,004 m³

Tejidos disponibles Available fabrics

Agora 3D — G1



Acabados para las bases Finishes for the bases

Madera fenólica
(alma negra)
Phenolic wood
(black core)

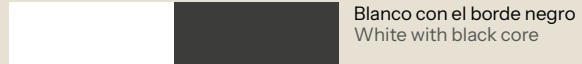

Otras especificaciones Other specifications

Pieza decorativa que no requiere
limpieza ni mantenimiento.

Decorative piece, does not require
cleaning or maintenance.

Base fenólica blanca de alma negra.
Interior de aluminio y guata.

White phenolic base with black core.
Aluminium and wadding interior

Puf Pool p.41

Puf Pool

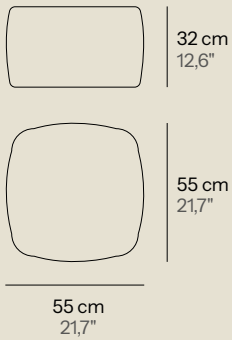

Peso 1,6 Kg
Weight 3,56 lb

Volumen 0,09 m³
Volume

Puf Pool Table

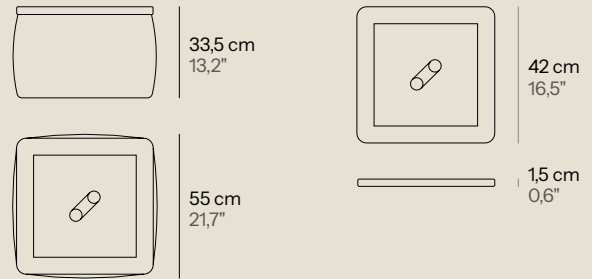

Peso 3,9 Kg
Weight 8,59 lb

Volumen 0,09 m³
Volume

Tejidos disponibles Available fabrics

Agora 3D – G1



Silvertex – G2



Heritage – G4



Elios – G4



Kantha (Trevira) – G5



Opciones de relleno para gama Agora 3D.
Filling options for Agora 3D fabric range.

100% BIOPS PES Filling

Compuesto por perlas de biomasa obtenidas de restos vegetales. Liger y resistente. Para productos de piscina.

Composed of biomass beads obtained from plant waste. Lightweight and resistant. Suitable for pool use.

Opciones de relleno para otros tejidos.
Filling options for other fabrics.

Mixture (70% shredded foam & 30% BIOPS PES)

Mezcla que combina confort y sostenibilidad. Ideal para exteriores, no apto para piscina.

A mixture that brings comfort and sustainability. Ideal for outdoor use, not suitable for pool use.

Pillow p.17

Cushion p.34

Pillow S

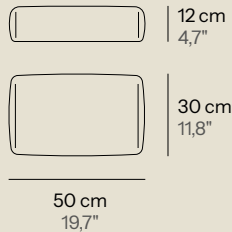

Pillow L

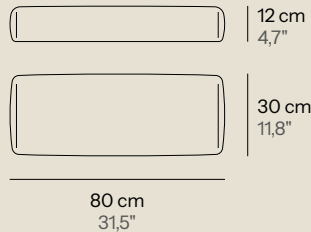

Cushion L

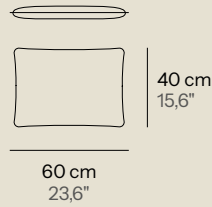

Cushion XL

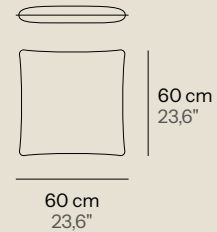

Peso 0,6 Kg
Weight 1,32 lb

Volumen 0,03 m³
Volume

Peso 1 Kg
Weight 2,20 lb

Volumen 0,07 m³
Volume

Peso 0,6 Kg
Weight 1,32 lb

Volumen 0,03 m³
Volume

Peso 1 Kg
Weight 2,20 lb

Volumen 0,07 m³
Volume

Tejidos disponibles
Available fabrics

OGO fabric catalogue:
Agora 3D — G1,
Silvertex — G2,
Batyline — G3,
Heritage — G4,
Elios — G4,
Kantha (Trevira) — G5

Este producto está disponible en todo el catálogo de tejidos de OGO, adaptándose al producto con el que quieras combinarlo.

This product is available in OGO's full fabric catalog, allowing you to match it with your chosen piece.

Opciones de relleno para gama Agora 3D.
Filling options for Agora 3D fabric range.

100% BIOPS PES Filling

Compuesto por perlas de biomasa obtenidas de restos vegetales. Ligero y resistente. Para productos de piscina.

Composed of biomass beads obtained from plant waste. Lightweight and resistant. Suitable for pool use.

Opciones de relleno para otros tejidos.
Filling options for other fabrics.

Mixture (70% shredded foam & 30% BIOPS PES)

Mezcla que combina confort y sostenibilidad. Ideal para exteriores, no apto para piscina.

A mixture that brings comfort and sustainability. Ideal for outdoor use, not suitable for pool use.

Otras especificaciones
Other specifications

Este producto es un complemento ideal para otras piezas como Bali, María o Llit Out.

This product is an ideal complement to other pieces such as Bali, María or Llit Out.

Consultar medidas especiales con fabricación.

Consult the factory for special measurements.

Products

Productos diseñados y fabricados artesanalmente en España.

Producto no nocivo para la salud. No debe ser utilizado por niños sin la supervisión de un adulto. OGO no se hace responsable del mal uso.

Las medidas totales de los productos de OGO que se muestran en este documento pueden variar entre 5cm +/- dependiendo de la tipología del producto y de las características de los diferentes tejidos.

La etiqueta descrita en la página 13 indica que el producto reúne tres de las características necesarias para ser usado en el agua (diseño, tejido Agora 3D y relleno 100% BIOPS PES). Estos son: Bali, Llit Out, María, Starfish, Sit Pool, Don Out Collection & Flower.

Todos los productos se entregan con una funda OGO diseñada para su transporte. Conserve la funda, puede utilizarla para proteger el producto en invierno si no desea utilizarlo en interiores.

Consulte a nuestro equipo si tiene alguna duda sobre los rellenos y el uso interior/exterior de los productos.

Products designed and handcrafted in Spain.

Product not harmful to health. Not for use by children without adult supervision. OGO is not responsible for misuse.

The total measurements of the products by OGO which are shown in this document can vary between 5cm +/- depending on the typology of the product and the characteristics of the different fabrics.

The tag described in page 13 indicates that the product combines three of the necessary characteristics to be used on water (design, Agora 3D fabric and 100% BIOPS PES filling). These are: Bali, Llit Out, María, Starfish, Sit Pool, Don Out Collection & Flower.

All products are delivered with an OGO cover designed for transport. Keep the cover, it can be used to protect the product in winter if you do not wish to use it indoors.

Consult our team if you have any doubts regarding fillings and indoor/outdoor usage of the products.

Recommendations for use

Los productos de nuestro catálogo no son juguetes. No permita que los niños jueguen solos en el agua sin la supervisión de un adulto. OGO no se hace responsable en caso de accidente.

El peso de los artículos aumenta al entrar en contacto con el agua, por lo que deben ser retirados de la misma con cuidado, y dependiendo del tamaño del producto, quizás incluso por más de dos personas.

En caso de contacto con el agua, el producto debe ser aclarado para eliminar restos de cloro y sal para protegerlo de daños innecesarios.

Se recomienda guardar la pieza una vez seco si no se va a utilizar en mucho tiempo. Para ello, utilice una funda. El tiempo que tarda en secarse puede variar de 4 a 7 días dependiendo del clima. Se recomienda colgarlo para que el aire corra por la superficie.

The products in our catalogue are not toys. Do not allow children to play alone in the water without the supervision of an adult. OGO is not responsible in case of accident.

The weight of the articles increases when in contact with water, thus they must be removed from it with care, and depending on the size of the product, perhaps even by more than two people.

In case of contact with water, the product must be rinsed in order to get rid of traces of chlorine and salt to protect it from unnecessary damages.

It is recommended to put away the furniture when dry if it is not going to be used in a long time. Use the cover for this. The time it takes in order to dry can vary from 4-7 days depending on the climate. We recommend hanging it up so that the air can run across the surface.

Cleaning guidelines

Para saber cómo limpiar cada tejido de nuestro catálogo escanea el siguiente QR y accede a las instrucciones de limpieza para cada caso. Si tienes necesidades específicas o alguna duda, contacta con el equipo.

To find out how to clean each fabric in our catalogue, scan the following QR and access the cleaning instructions for each case. If you have specific needs or any questions, please contact the team.





Art Direction
Estudio Menta

Words by
Marta Patallo @losbuclesdemarta,
Estudio Menta

Editing
Estudio Menta,
OGO Furniture

Photography
Ángel Segura,
Estudio Menta

OGO is a brand of 1 Tapiza S.L.
C/ Argenters, 31, Pol. Ind. El Alter,
46290, Alcàsser, València, España

Contact
+34 961 241 764
info@ogofurniture.com

ogofurniture.com

The *Good* Life